

JACT

JACT

无锡市艾克特电气股份有限公司
WUXI JACT ELECTRIC CO.,LTD.



JACT ELECTRIC

ENTERPRISE HANDBOOK



0510/
85380261



0510/
85380261



无锡新吴区菱湖大道200号
中国传感网国际创新园A栋10楼

10 / F, Building A, China Sensor Network
International Innovation Park, No. 200, Linghu
Avenue, Xinwu District, Wuxi.

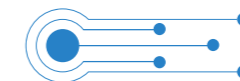

无锡市艾克特电气股份有限公司
WUXI JACT ELECTRIC CO.,LTD.



COMPANY PROFILE

企业简介

◎无锡市艾克特电气股份有限公司成立于2013年，其总部位于中国传感网国际创新园A栋7、10、11楼；

◎无锡市艾克特电气股份有限公司是一家拥有完全自主知识产权，专注于工业自动化产品的研发、生产和销售，定位服务于工业设备制造商，以自动控制技术、矢量变频技术为基础，持续为客户提供实用的产品和便捷的服务，并为特定客户设计专用产品和一体化定制方案；

◇Wuxi JACT Electric Co., Ltd. was founded in 2013, located in China Sensor Network International Innovation Park Building A F7, F10 and F11.

◇Wuxi JACT Electric Co., Ltd with completely intellectual property rights mainly engaged in the research, development, production, sales and service of the inverters. Our company is positioned to serve the industrial equipment manufacturers. On the basis of AC drive automatic control technology, we not only provide customers with practical products and convenient services continuously, but also individually tailored product and comprehensive solution for particular industry.



◎公司在电气驱动的核心技术上拥有与国际领先技术同步的矢量控制技术和转矩控制技术，通过不断的技术创新和广泛的国际技术交流，全面掌握各项核心技术，极大提高了产品的可靠性和对环境的适应性；

◎目前公司产品已经广泛应用于冶金、起重、石油、化工、机床、建材、陶瓷、塑料、金属加工、石材加工、木材加工、空压机、洗衣机、供水、空调、市政工程、纺织、印刷、矿山等各个领域；

◇In the core technology of motor drive, our company has the vector control technology and torque control technology that are synchronous with international advanced technical level. Through continuous technical innovation and extensive international technology communications, we have mastered the core technology and capacity of perfect design and production. Therefore, the reliability of the product and the adaptability of the environment are greatly improved.

◇Now our inverters are widely used in metallurgy, lifting, petroleum, chemical industries, machine tools, building materials, ceramic, plastic, metal processing, stone processing, wood processing, air compressors, washing machines, water supplying, air conditioning, municipal engineering, textile, printing, mining and other industries.



AT500

AC DRIVE

变频器

- 采用国际领先的矢量控制技术，高性能高精度电机控制：V/F、开环矢量、闭环矢量；
- 低速大转矩，0.5Hz/150%(SVC),0Hz/180%(FVC)；
- 宽功率设计，支持多种电机配置和多种编码器，可实现高精度闭环控制；
- 集速度控制，转矩控制和位置控制于一体，可广泛应用于同步电机和异步电机控制；
- 独立风道设计，选用长寿命大风量散热风机，提高整机散热效率，保障变频器稳定运行；
- 调试便捷，丰富的硬件接口和软件功能，能满足多种不同的工业应用场合；

- Advanced vector motor control algorithm, high performance and high precision motor control; open loop V/F & SVC control, closed loop FVC control.
- The low-frequency large-torque: 150% at 0.5 Hz for SVC;180% at 0 Hz for FVC.
- Wide power design (0.7kW-710kW) and support various motor configurations, Support a variety of encoders, can achieve high-precision closed-loop control.
- It integrates speed control, torque control and position control, and can be widely used in synchronous and asynchronous motor control.
- Independent air duct design, long life and large air volume cooling fan to improve the cooling efficiency of the inverter and ensure the stable operation of the inverter.



PRODUCT DISPLAY

GENERAL SPECIFICATIONS

技术参数



| AT500 - T3 - 011G / 015PB | |
|--|---|
| ① 变频器系列 Inverter Series | ③ 重载功率 Constant Torque 011: 11kW |
| ② 电压等级 Voltage Degree S2: AC 1PH 220V T3: AC 3PH 380V | ④ 轻载功率 Constant Light Load 015: 15kW |
| | ⑤ 内置制动单元 With Built-in Braking Unit |

| 型号 Model | 电源容量 Power Capacity (kVA) | 输入电流 Input Current (A) | 输出电流 Output Current (A) | 适配电机 Motor | |
|----------------------------------|------------------------------|---------------------------|----------------------------|------------|----------|
| | | | | 功率 kW | 马力 HP |
| 单相电源 Single Phase: 220V, 50/60Hz | | | | | |
| AT500-S2-0R4GB | 1 | 5.4 | 2.3 | 0.4 | 0.5 |
| AT500-S2-0R7GB | 1.5 | 8.2 | 4 | 0.75 | 1 |
| AT500-S2-1R5GB | 3 | 14 | 7 | 1.5 | 2 |
| AT500-S2-2R2GB | 4 | 23 | 9.6 | 2.2 | 3 |
| 三相电源 Three Phase: 380V, 50/60Hz | | | | | |
| AT500-T3-0R7G/1R5PB | 1.5 | 3.4 | 2.1 | 0.75 | 1 |
| AT500-T3-1R5G/2R2PB | 3 | 5 | 3.8 | 1.5 | 2 |
| AT500-T3-2R2G/4R0PB | 4 | 5.8 | 5.1 | 2.2 | 3 |
| AT500-T3-4R0G/5R5PB | 5.9 | 10.5 | 9 | 3.7 | 5 |
| AT500-T3-5R5G/7R5PB | 8.9 | 14.6 | 13 | 5.5 | 7.5 |
| AT500-T3-7R5G/011PB | 11 | 20.5 | 17 | 7.5 | 10 |
| AT500-T3-011G/015PB | 17 | 26 | 25 | 11 | 15 |
| AT500-T3-015G/018PB | 21 | 35 | 32 | 15 | 20 |
| AT500-T3-018G/022PB | 24 | 38.5 | 37 | 18.5 | 25 |
| AT500-T3-022G/030PB | 30 | 46.5 | 45 | 22 | 30 |
| AT500-T3-030G/037P | 40 | 62 | 60 | 30 | 40 |
| AT500-T3-037G/045P | 57 | 76 | 75 | 37 | 50 |
| AT500-T3-045G/055P | 69 | 92 | 91 | 45 | 60 |
| AT500-T3-055G/075P | 85 | 113 | 112 | 55 | 75 |
| AT500-T3-075G/090P | 114 | 157 | 150 | 75 | 100 |
| AT500-T3-090G/110P | 134 | 180 | 176 | 90 | 125 |
| AT500-T3-110G/132P | 160 | 214 | 210 | 110 | 150 |
| AT500-T3-132G/160P | 192 | 256 | 253 | 132 | 180 |
| AT500-T3-160G/200P | 231 | 307 | 304 | 160 | 210 |
| AT500-T3-200G/220P | 250 | 385 | 377 | 200 | 270 |
| AT500-T3-220G/250P | 280 | 430 | 426 | 220 | 300 |
| AT500-T3-250G/280P | 355 | 468 | 465 | 250 | 335 |
| AT500-T3-280G/315P | 396 | 525 | 520 | 280 | 380 |
| AT500-T3-315G/355P | 445 | 590 | 585 | 315 | 420 |
| AT500-T3-355G/400P | 500 | 665 | 650 | 355 | 470 |
| AT500-T3-400G/450P | 565 | 785 | 725 | 400 | 530 |
| AT500-T3-450G | 630 | 883 | 820 | 450 | 600 |

DIMENSIONS

技术参数

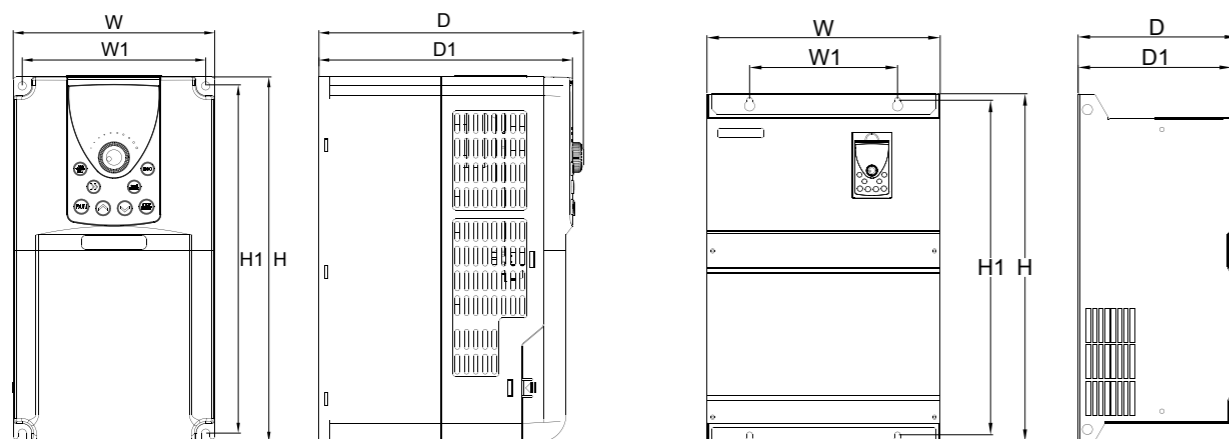

| 型号 Model | 安装孔位mm Location Of Holes | | 外型尺寸mm Appearance Size | | | | 安装孔径mm Diameter Of Hole |
|---------------------|-----------------------------|-------|---------------------------|-----|-------|-------|----------------------------|
| | W1 | H1 | H | W | D1 | D | |
| AT500-S2-0R7GB | 71.5 | 121.5 | 132 | 80 | 105.5 | 114.6 | φ 4.5 |
| AT500-S2-1R5GB | | | | | | | |
| AT500-S2-2R2GB | | | | | | | |
| AT500-T3-0R7G/1R5PB | 88.4 | 168.4 | 180 | 100 | 152 | 159 | φ 5.5 |
| AT500-T3-1R5G/2R2PB | | | | | | | |
| AT500-T3-2R2G/4R0PB | | | | | | | |
| AT500-T3-4R0G/5R5PB | 118.4 | 224.5 | 236 | 130 | 163.5 | 170.5 | φ 5.5 |
| AT500-T3-5R5G/7R5PB | | | | | | | |
| AT500-T3-7R5G/011PB | | | | | | | |
| AT500-T3-011G/015PB | 141 | 243 | 260 | 155 | 175 | 182 | φ 7 |
| AT500-T3-015G/018PB | | | | | | | |
| AT500-T3-018G/022PB | | | | | | | |
| AT500-T3-022G/030PB | 190 | 273.5 | 291.5 | 197 | 175 | 182 | φ 6 |
| AT500-T3-030G/037P | | | | | | | |
| AT500-T3-037G/045P | | | | | | | |
| AT500-T3-045G/055P | 260 | 555 | 575 | 340 | 250 | 259 | φ 10 |
| AT500-T3-055G/075P | | | | | | | |
| AT500-T3-075G/090P | | | | | | | |
| AT500-T3-090G/110P | 260 | 590 | 610 | 410 | 270 | 279 | φ 10 |
| AT500-T3-110G/132P | | | | | | | |
| AT500-T3-132G/160P | | | | | | | |
| AT500-T3-160G/185P | 360 | 845 | 880 | 530 | 367 | 376 | φ 14 |
| AT500-T3-200G/220P | | | | | | | |
| AT500-T3-220G/250P | | | | | | | |
| AT500-T3-250G/280P | 480 | 1005 | 1040 | 650 | 411 | 420 | φ 14 |
| AT500-T3-280G/315P | | | | | | | |
| AT500-T3-315G/355P | | | | | | | |
| AT500-T3-355G/400P | 600 | 1252 | 1300 | 815 | 427 | 436 | φ 14 |
| AT500-T3-400G/450P | | | | | | | |

GENRAL WIRING DIAGRAM

总接线图

主回路
Main loop

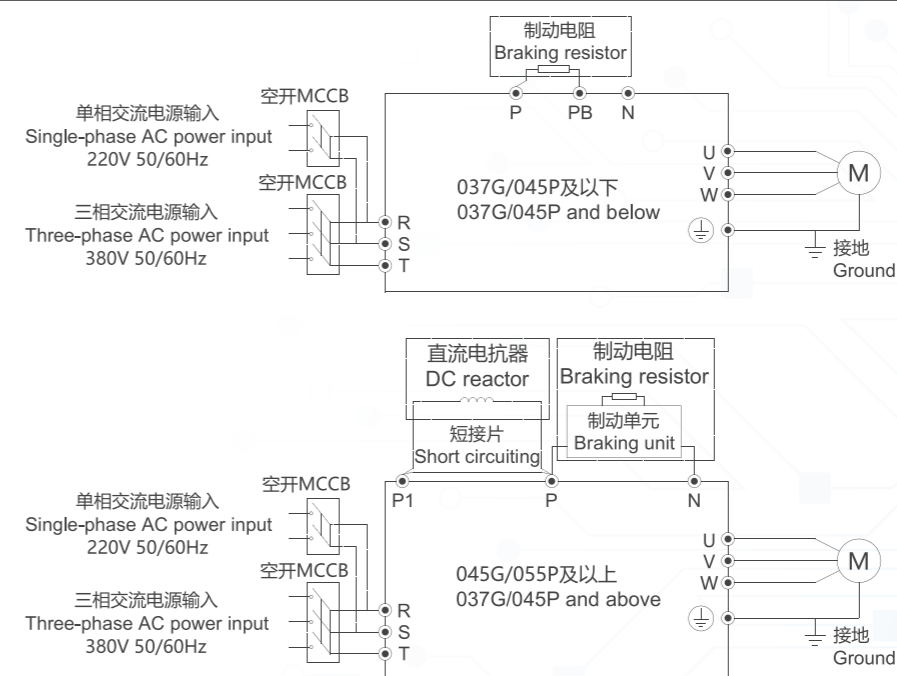

控制回路
Control loop

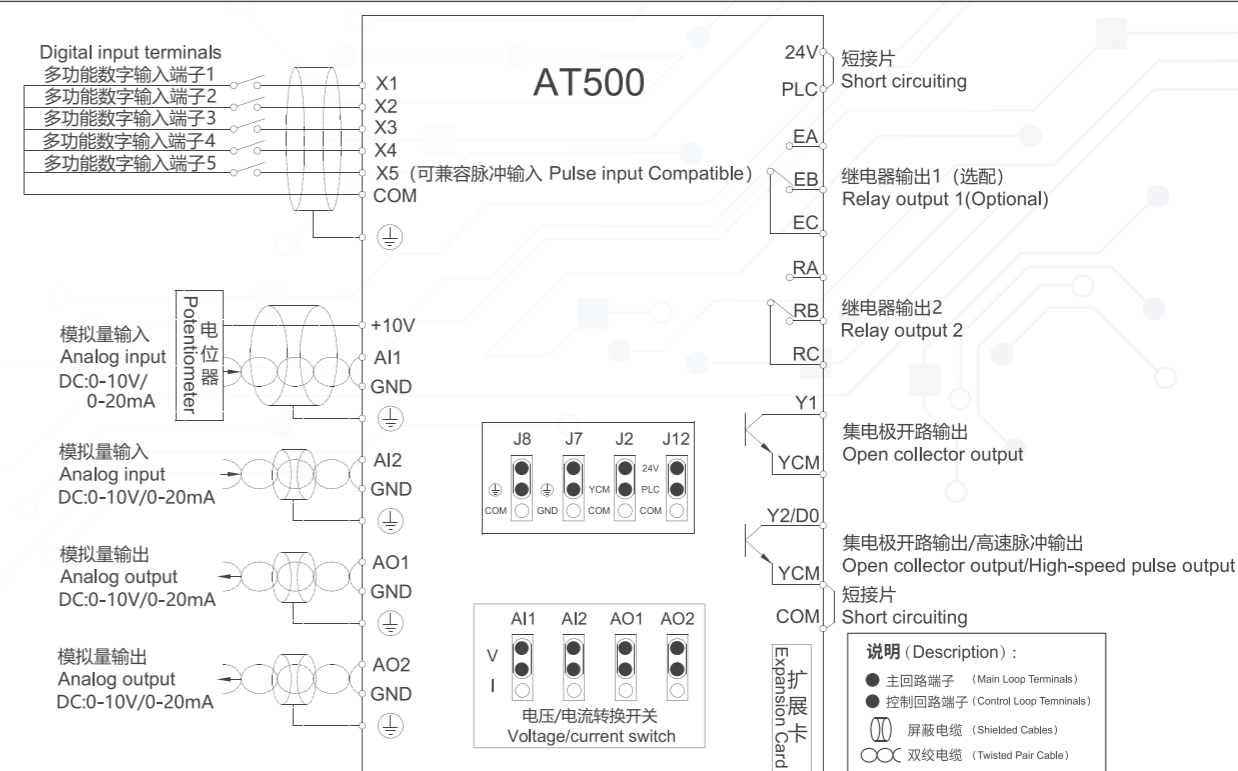

AT300

AC DRIVE

变频器

- ⊙ 书本式窄体设计，全新结构布局，最大缩小体积50%，配电成本节省50%；
- ⊙ 独立风道，上下直通，高效散热；可并排安装，合理利用空间，大大降低电气柜成本；
- ⊙ 优异的控制算法，丰富的硬件接口和软件功能，全方位的保护机制，提高产品的可靠性；

◇ The book type VFD design, new structural design, space saving 50%, distribution cost saving 50%.

◇ Independent air duct, up and down straight, efficient heat dissipation. Can be installed side-by-side, reasonable use of space, greatly reducing the cost of electrical cabinet.

◇ Advanced control algorithm, the enriched hardware configurations and software functions, reliable protection design, ensure the reliability of the product.

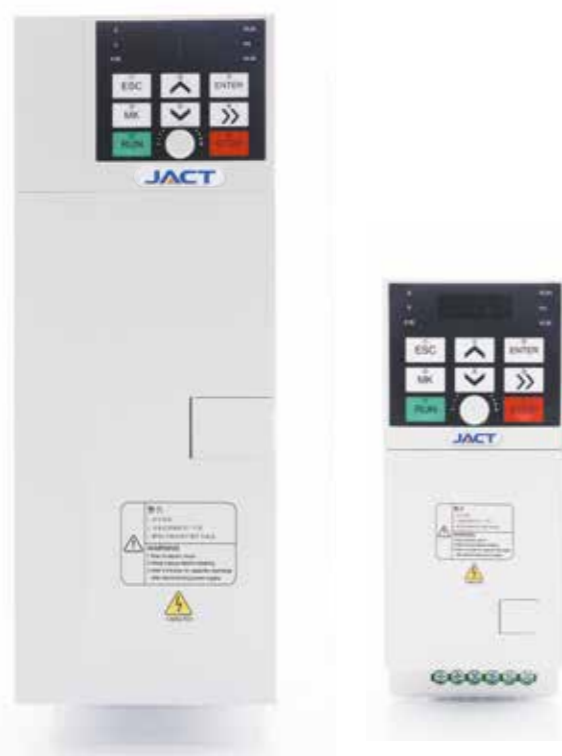

PRODUCT DISPLAY

GENERAL SPECIFICATIONS

技术参数

| AT300 - T3 - 011B | |
|--|---|
| ① 变频器系列 Inverter Series | ③ 功率 Inverter Power 011: 11kW |
| ② 电压等级 Voltage Degree S2: AC 1PH 220V T3: AC 3PH 380V | ④ B: 内置制动单元 With Built-in Braking Unit |



| 型号 Model | 电源容量 Power Capacity (kVA) | 输出电流 Output Current (A) | 输入电流 Input Current (A) | 适配电机 Motor | |
|---------------------------------|------------------------------|----------------------------|---------------------------|------------|----------|
| | | | | 功率 kW | 马力 HP |
| 三相电源 Three phase: 380V, 50/60Hz | | | | | |
| AT300-T3-0R7B | 2.2 | 2.7 | 3.4 | 0.75 | 1 |
| AT300-T3-1R5B | 3.2 | 4.0 | 5 | 1.5 | 2 |
| AT300-T3-2R2B | 4 | 5.0 | 5.8 | 2.2 | 3 |
| AT300-T3-3R7B | 6.8 | 8.5 | 10.5 | 3.7 | 5 |
| AT300-T3-5R5B | 10 | 12.5 | 14.6 | 5.5 | 7.5 |
| AT300-T3-7R5B | 14 | 17.5 | 20.5 | 7.5 | 10 |
| AT300-T3-011B | 17 | 25 | 26 | 11 | 15 |

DIMENSIONS & GENERAL WIRING DIAGRAM

技术参数 & 总接线图

AT100 AC DRIVE 变频器

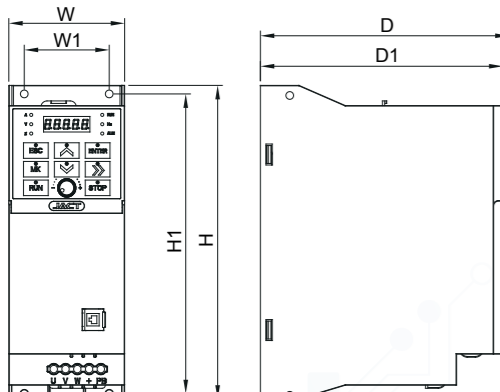

| 型号 Model | 安装孔位mm Location Of Holes | | 外型尺寸mm Appearance Size | | | | 安装孔径mm Diameter Of Hole |
|---------------|-----------------------------|-----|---------------------------|-----|-----|-----|----------------------------|
| | W1 | H1 | H | W | D1 | D | |
| AT300-T3-0R7B | | | | | | | |
| AT300-T3-1R5B | | | | | | | |
| AT300-T3-2R2B | 55 | 193 | 202 | 75 | 157 | 161 | φ5 |
| AT300-T3-3R7B | | | | | | | |
| AT300-T3-5R5B | | | | | | | |
| AT300-T3-7R5B | 80 | 308 | 322 | 108 | 176 | 180 | φ5 |

- ⊙ 优化结构设计，节省安装空间和配电成本；
- ⊙ 独立风道，上下直通，高效散热；
- ⊙ 丰富的硬件接口和软件功能，全方位的保护机制，提高产品的可靠性；

- ◇ Optimize Structure Design, Saving Installation Space And Distribution Cost.
- ◇ Independent air duct, up and down straight, efficient heat dissipation.
- ◇ The enriched hardware configurations and software functions, reliable protection design, ensure the reliability of the product.

主回路 Main loop

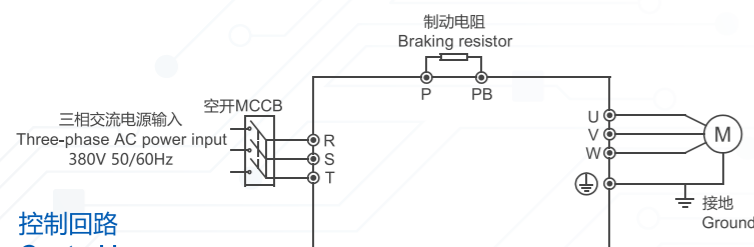

控制回路 Control loop

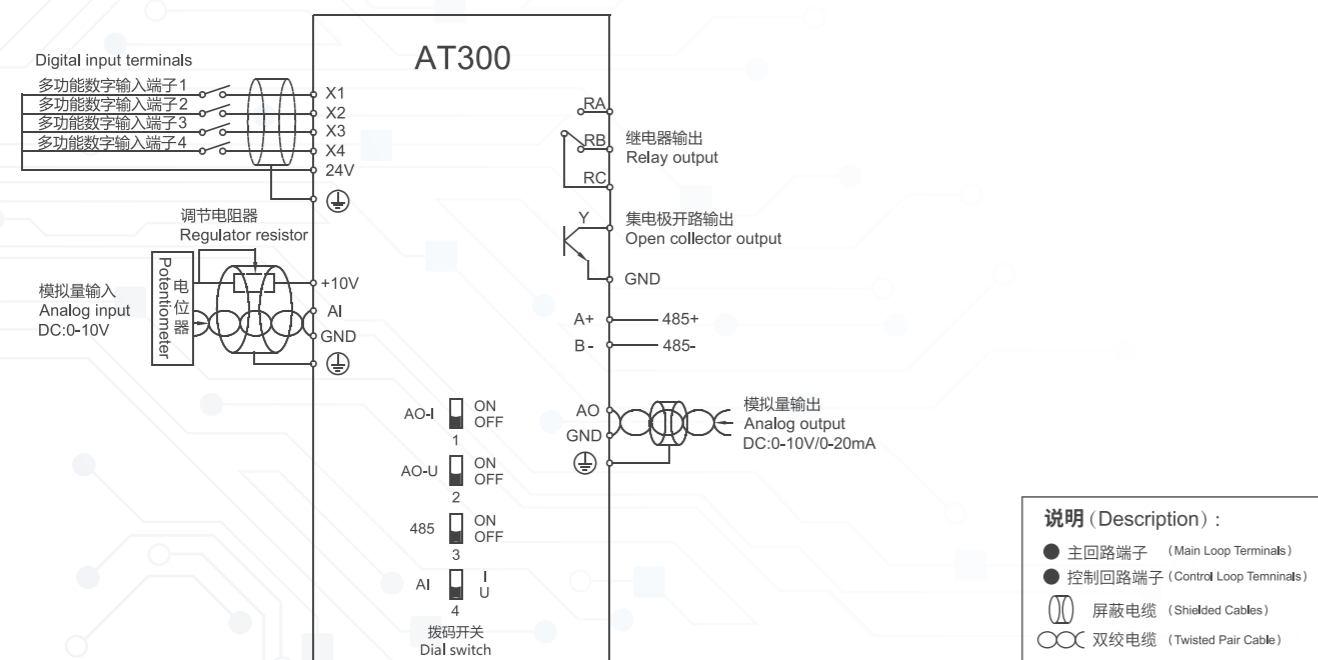

PRODUCT DISPLAY

GENERAL SPECIFICATIONS

技术参数

| AT100 - T3 - 011B | |
|--|---|
| 变频器系列 Inverter Series | 功率 Inverter Power 011: 11kW |
| 电压等级 Voltage Degree S2: AC 1PH 220V T3: AC 3PH 380V | B: 内置制动单元 With Built-in Braking Unit |



| 型号 Model | 电源容量 Power Capacity (kVA) | 输入电流 Input Current (A) | 输出电流 Output Current (A) | 适配电机 Motor |
|----------------------------------|---------------------------|------------------------|-------------------------|------------|
| 单相电源 Single Phase: 220V, 50/60Hz | | | | |
| AT100-S2-0R7G | 2 | 8.2 | 5 | 0.75 |
| AT100-S2-1R5G | 2.8 | 14 | 7 | 1.5 |
| AT100-S2-2R2G | 4.4 | 23 | 11 | 2.2 |
| AT100-S2-3R7G | 6.8 | 32.5 | 16 | 3.7 |
| 三相电源 Three Phase: 380V, 50/60Hz | | | | |
| AT100-T3-0R7G | 2.2 | 3.4 | 2.7 | 0.75 |
| AT100-T3-1R5G | 3.2 | 5 | 4 | 1.5 |
| AT100-T3-2R2G | 4 | 5.8 | 5 | 2.2 |
| AT100-T3-3R7G | 6.8 | 10.5 | 8.5 | 3.7 |
| AT100-T3-5R5G | 10 | 14.6 | 12.5 | 5.5 |
| AT100-T3-7R5G | 14 | 20.5 | 17.5 | 7.5 |

DIMENSIONS & GENERAL WIRING DIAGRAM

技术参数 & 总接线图

| 型号 Model | 安装孔位mm Location Of Holes | | 外型尺寸mm Appearance Size | | | | 安装孔径mm Diameter Of Hole |
|---------------|--------------------------|-----|------------------------|-----|-------|-------|-------------------------|
| | W1 | H1 | H | W | D1 | D | |
| AT100-S2-0R7G | 77 | 137 | 150 | 90 | 110.5 | 117.2 | φ5 |
| AT100-S2-1R5G | | | | | | | |
| AT100-S2-2R2G | 103 | 204 | 220 | 118 | 141 | 147.2 | φ6 |
| AT100-S2-3R7G | | | | | | | |
| AT100-T3-0R7G | 77 | 137 | 150 | 90 | 110.5 | 117.2 | φ5 |
| AT100-T3-1R5G | | | | | | | |
| AT100-T3-2R2G | | | | | | | |
| AT100-T3-3R7G | 103 | 204 | 220 | 118 | 141 | 147.2 | φ6 |
| AT100-T3-5R5G | | | | | | | |
| AT100-T3-7R5G | | | | | | | |

主回路 Main loop

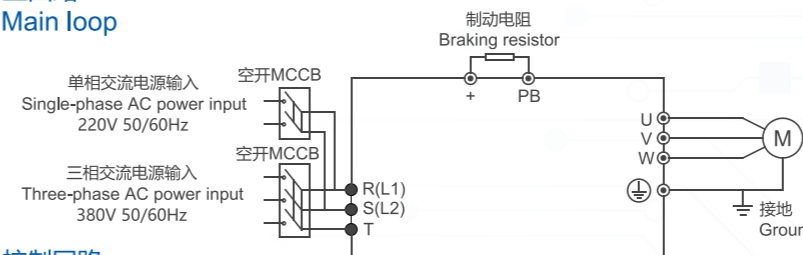

控制回路 Control loop

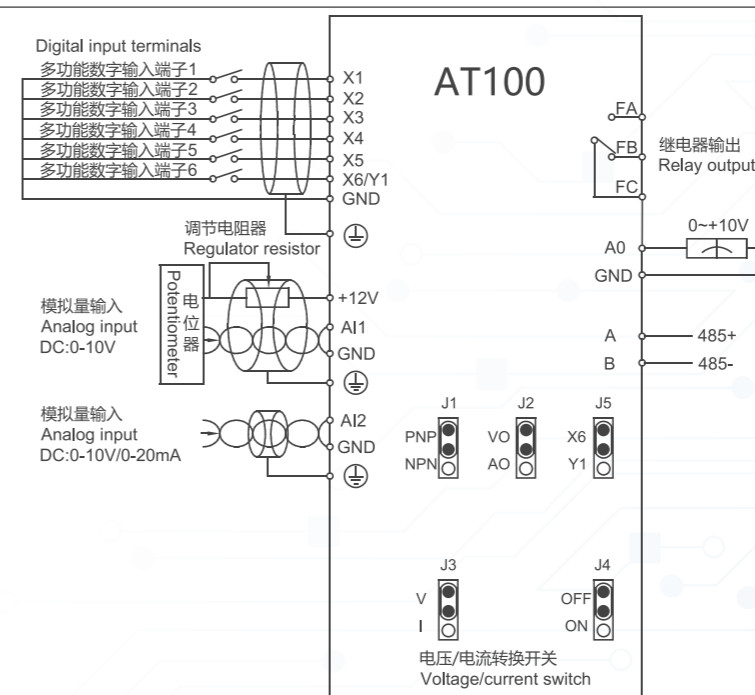

说明 (Description):

- 主回路端子 (Main Loop Terminals)
- 控制回路端子 (Control Loop Terminals)
- Ⓢ 屏蔽电缆 (Shielded Cables)
- Ⓞ 双绞电缆 (Twisted Pair Cable)

TDS SERVO DRIVE

TDS伺服节能控制器

- ⊙增强型振动抑制;
- ⊙增益自调整;
- ⊙速度环带宽3.0kHz;
- ⊙配线简单方便;

- ◇ Enhanced vibration suppression.
- ◇ Gain self adjustment.
- ◇ Speed band width 3.0KHZ.
- ◇ Simple And Convenient Wiring.

- ⊙专用三防漆, 采用全防护的喷漆工艺;
- ⊙环境适应性强, 使用安全可靠;
- ⊙丰富的应用功能;
- ⊙一键式调试;

- ◇ Enhanced vibration suppression.
- ◇ Gain self adjustment.
- ◇ Rich Application Functions.
- ◇ One Step Debugging.



IOT REMOTE CONTROL

JACT远程监控云平台

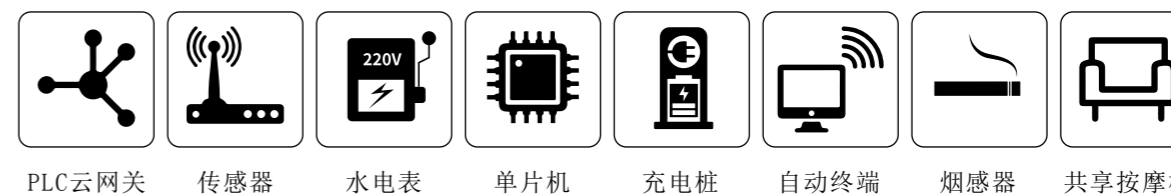
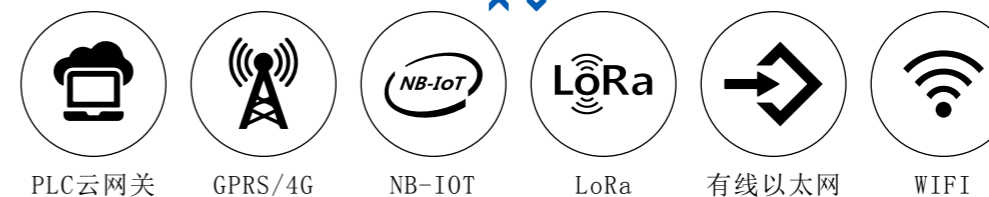

VFD

FOR TEXTILE APPLICATION

穿墙型变频器

AT580

AC DRIVE

变频器

- ⊙采用无风扇设计、穿墙式安装方式，可以更好的满足纺织环境；
 - ⊙内部控制板特殊三防漆处理，适应高温、高湿复杂环境，整机可以在环境温度50度不降容使用；
 - ⊙防棉絮设计，有效防止异物进入变频器内部，提高防护等级，适用于环境恶劣场合；
 - ⊙采用国际领先技术的矢量控制算法，高性能高精度电机控制；硬件设计升级，有效改善系统EMC电磁兼容性，大幅度降低干扰，提升系统适应能力；
- ◇Designed with no fan and through wall installtion ,the VFD can be better satisfy the requirement of spinnng environment.
- ◇Coated with special three-proof paint, the internal control board can be used in complex environments with high temperature and high humidity.
- ◇The cotton fiber prevention design can effectively prevent dust from entering the inverter and improve the protection level, which is suitable for the harsh environment.
- ◇Adopt the vector control algorithm of international leading technology, high performance and high precision motor control. Effectively improve the EMC of the system, greatly reduce interference, and improve the adaptability of the system.



- ⊙15kW以上系列内置直流电抗器，有效提高输入侧功率因素，降低电网无功损耗，有效消除高次谐波，提高稳定性；
 - ⊙高密度防尘网设计，有效防止灰尘进入变频器内部，提高防护等级，适用于环境恶劣场合；内部控制板特殊三防漆处理，适应高温、高湿复杂环境，整机可以在环境温度50度不降容使用；
 - ⊙内部控制板特殊三防漆处理，适应高温、高湿复杂环境，整机可以在环境温度50度不降容使用；
 - ⊙隔离风道设计，采用定制高防护、大风量直流风扇，提高散热效率，有效降低温升，保障可靠运行；
 - ⊙易于维护，散热器位置盖板可拆卸，方便彻底清理散热器灰尘；
- ◇Built-in DC reactor (15kW and above), improve power factor of input side effectively, reduce ractive loss of the power gird,eliminate high-order harmonics and improve stability.
- ◇High density dust-proof net design can effectively prevent dust from entering the inverter and improve the protection level, which is suitable for the harsh environment.
- ◇Coated with special three-proof paint, the internal control board can be used in complex environments with high temperature and high humidity.
- ◇Independent air duct, customized high dust-proof and large air volume DC fans, improve heat dissipation efficiency, effectively reduce temperature rise and ensure reliable operation.
- ◇Easy to maintain, the radiator position cover plate is detachable, convenient to clean the radiator dust thoroughly.



INTEGRATED FOR CONSTRUCTION LIFTING

施工升降梯专用一体机

- ⊙舒适的用户体验：0.5Hz输出力矩150%，确保启动停机时运行平稳；
 - ⊙专用抱闸控制逻辑，确保系统安全可靠；
 - ⊙全面可靠保护功能：除变频器基本保护功能外，还有制动电阻、控制电源保护等；
 - ⊙多种附加功能：中英文语音提示、称重功能、工变频转换等功能；
 - ⊙友好的人机交互：GPS/GPRS数据实时监控（扩展），自动平层控制（扩展），液晶显示屏（扩展）；
- ◇ Comfortable user experience: output torque of 0.5Hz is 150%, ensuring stable operation during startup and shutdown.
 - ◇ Special holding brake control logic ensures the safety and reliability of the system.
 - ◇ Reliable protection function: the basic protection function of inverter, brake resistance protection, control power supply protection, etc.
 - ◇ Various additional functions: Chinese and English voice prompt, weighing function, frequency conversion and other functions.
 - ◇ Friendly interactive interface: Real time monitoring of GPS / GPRS data (extension), Automatic leveling control (Extended); LCD display (Extended).



ENERGY SAVING INTEGRATED SYSTEM

自动化节能系统

- ⊙节能改造专用一体机，内置PID控制程序，具有自动休眠和唤醒功能，在满足客户实际需求的前提下节省电能；
 - ⊙实现车间温湿度自动控制；
 - ⊙集中控制，运行数据、历史数据和报表数据可视化；
 - ⊙节电率20%--60%，回报周期约为18个月；
- ◇ Energy saving, built-in PID control program, with automatic sleep and wake-up function, in order to meet the actual needs of customers under the premise of energy saving.
 - ◇ Automatically control temperature and humidity.
 - ◇ Centralized control, operation data, historical data and report data visualization.
 - ◇ Energy saving 20%–60%, payback in about 18 months.



HYDRAULIC SERVO

电液伺服驱动器

- ⊙采用国际领先技术的矢量控制算法，高性能高精度电机控制；
- ⊙硬件设计升级，有效改善系统EMC电磁兼容性，大幅度降低干扰，提升系统适应能力；
- ◇Adopt the vector control algorithm of international leading technology, high performance and high precision motor control.
- ◇Effectively improve the EMC of the system, greatly reduce interference, and improve the adaptability of the system.



AEVD ELECTRIC VEHICLE CONTROLLER

AEVD电动汽车控制器



- ⊙业界领先的同步电机控制算法；
- ⊙有速度矢量控制模式和无速度矢量控制模式，无缝切换；
- ⊙无速度矢量控制算法；
- ⊙转矩控制和速度控制一体化；
- ⊙满足客户油泵控制、气泵控制和电动空调的高性能需求；
- ◇Energy saving, built-in PID control program.
- ◇with automatic sleep and wake-up function.
- ◇in order to meet the actual needs of customers under the premise of energy saving.
- ◇Automatically control temperature and humidity.
- ◇Centralized control, operation data, historical data and report data visualization.

KY550 HDMI

- ⊙7寸彩屏，键盘与触摸屏控制选择；
- ⊙485控制、端子控制；
- ⊙丰富用户接口、定制化软件设计；
- ◇7-inch color display, keyboard and touch screen control options.
- ◇485 Control, terminal contro.
- ◇Enrich user interface and design customized. software.



COMPANY ADDRESS

DOMESTIC AND FOREIGN OFFICES

网点分布

